

OEM pressure sensor

For mobile working machines, CANopen[®]/SAE J1939

Model MH-4-CAN

WIKA data sheet PE 83.02



For further approvals,
see page 6

CANopen[®] **SAE J1939**

Applications

Working and control pressure measurement in:

- Construction equipment
- Agricultural and forestry machines
- Mobile cranes and mobile elevating work platforms (MEWP)
- Material handling equipment and municipal vehicles

Special features

- Developed for the extreme operating conditions in mobile working machines
- Highest signal stability and integrity thanks to CANopen[®]
- Reliability and highest accuracy over the entire life cycle
- Customer-specific adaptations and individualisation
- High production capacities

Description

The MH-4-CAN, based on the MH-4, is a powerful, reliable and extremely resilient pressure sensor for mobile working machines. Even under demanding conditions, the sensor delivers constant, precise measured data and ensures high operational safety. The special feature of the MH-4-CAN is, as the name suggests, the CANopen[®] or SAE J1939 serial interface. This enables use in complex machines and offers the advantage of simple and cost-effective system expansion with the bridging of large distances while simultaneously ensuring signal stability and signal integrity.

Developed for the specific requirements in mobile working machines

The MH-4-CAN meets high demands and measures with high precision at temperatures between -40 and +100 °C [-40 ...+212 °F]. With its up to 3 times overpressure limit, the sensor withstands hydraulic pressure spikes – and is optionally available with a restrictor. Thanks to metallic shielding, the MH-4-CAN works interference-free at field strengths of up to 60 V/m. In addition, vibrations up to 40 g and shocks up to 100 g have no influence on the measurement quality.



OEM pressure sensor, model MH-4-CAN

Highest reliability over the entire life cycle

Whether dust, humidity, heat or mechanical stress: The MH-4-CAN pressure sensor is optimised for mobile use, particularly safe in operation and thus continuously dependable. The maintenance-free instrument design ensures a particularly low total cost of ownership. Even after more than 100 million load cycles, the long-term drift is still less than 0.1 % FS.

Think big – with WIKA as an OEM supplier

Secure supply chains, high quality standards and a comprehensive range of services worldwide make WIKA a reliable OEM supplier – especially for large volume orders. MH-4 pressure sensors are available directly, in high quantities, with commonly used electrical connections and pressure connections. Customer-specific interfaces and adaptations can be realised together – including an option for brand labelling.

Specifications

| Overview of versions | |
|----------------------|--|
| Model | Description |
| MH-4 | OEM pressure sensor |
| MH-4 (v) | OEM pressure sensor with pressure compensation element (v = vented) → The pressure compensation element ensures higher accuracy for measuring ranges < 160 bar [2,000 psi]. → The pressure compensation element is available for selected electrical connections. → Not suited to applications involving diesel fuels, ambient conditions involving salt mist and extreme temperature fluctuations. |

| Accuracy specifications | |
|--------------------------------------|--|
| Non-linearity per IEC 62828-1 | ≤ ±0.25 % of span (BFSL) ¹⁾ |
| Accuracy | → See "Total probable error" below |
| Max. measured error per IEC 62828-1 | → See "Total probable error" below |
| Total probable error per IEC 62828-2 | → See "Total probable error" below |
| Long-term drift per IEC 62828-1 | ≤ ±0.1 % of span |
| Reference conditions | Per IEC 62828-1 |

1) Applies to SAE J1939 at a zero point of +0.5 % ... full scale value of -0.5 %

Total probable error

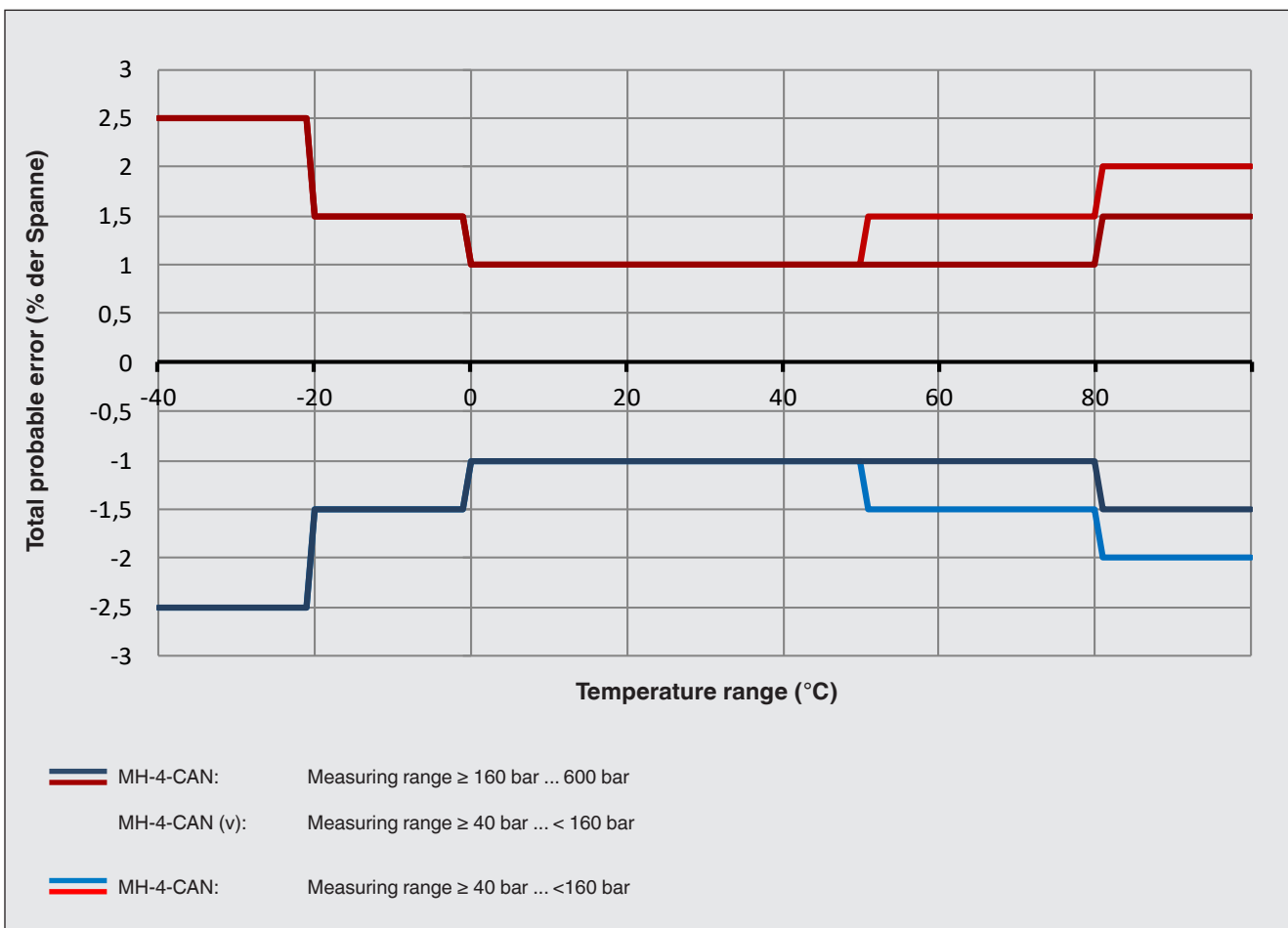

Measuring ranges, gauge pressure

| bar | |
|-----------|--------------|
| MH-4-CAN | MH-4-CAN (v) |
| 0 ... 40 | 0 ... 40 |
| 0 ... 60 | 0 ... 60 |
| 0 ... 100 | 0 ... 100 |
| 0 ... 160 | - |
| 0 ... 250 | - |
| 0 ... 400 | - |
| 0 ... 600 | - |

| psi | |
|-------------|--------------|
| MH-4-CAN | MH-4-CAN (v) |
| 0 ... 500 | 0 ... 500 |
| 0 ... 1.000 | 0 ... 1.000 |
| 0 ... 1.500 | 0 ... 1.500 |
| 0 ... 2.000 | - |
| 0 ... 3.000 | - |
| 0 ... 5.000 | - |
| 0 ... 8.000 | - |

→ Other measuring ranges on request.

| Further details on: Measuring range | |
|---|--|
| Units | <input type="checkbox"/> bar <input type="checkbox"/> psi <input type="checkbox"/> MPa |
| Maximum working pressure | → Corresponds to the upper measuring range value / measuring range full scale value |
| Overpressure limit per IEC 62828-2 | The overpressure limit is based on the measuring range. Depending on the selected process connection and sealing, restrictions in overpressure limit can result. |
| Measuring range ≤ 400 bar [≤ 5,000 psi] | 3 times |
| Measuring range 600 bar [8,000 psi] | 2 times |
| Vacuum resistance | Yes |

| Process connection | | | | | |
|--|----------------------------------|------------------------|------------------------|---|---|
| Standard | Thread size | Max. measuring range | Overpressure limit | Sealing | |
| DIN EN ISO 1179-2 (formerly DIN 3852-E) | G ¼ A | 600 bar [8,700 psi] | 858 bar [12,440 psi] | <input type="checkbox"/> NBR <input type="checkbox"/> FPM/ <input type="checkbox"/> FKM | |
| DIN EN ISO 9974-2 (formerly DIN 3852-E) | M14 x 1.5 | 600 bar [8,700 psi] | 858 bar [12,440 psi] | | |
| ISO 6149-2 | M14 x 1.5 | 600 bar [8,700 psi] | 858 bar [12,440 psi] | | |
| JIS B 2351-1 | G ¼ B x 10, form O with collar | 600 bar [8,700 psi] | 858 bar [12,440 psi] | | |
| | G ⅜ A, form O with collar | 600 bar [8,700 psi] | 858 bar [12,440 psi] | | |
| SAE J514 (Compatible for threaded holes SAE J1926) | 7/16-20 UNF, O-ring BOSS | 600 bar [8,700 psi] | 858 bar [12,440 psi] | | |
| | 9/16-18 UNF-2A, O-ring BOSS | 600 bar [8,700 psi] | 858 bar [12,440 psi] | | |
| | 3/4-16 UNF-2A, O-ring BOSS | 600 bar [8,700 psi] | 858 bar [12,440 psi] | | |
| | 7/16-20 UNF-2A, sealing cone 74° | 800 bar [11.600 psi] | 1,144 bar [16,500 psi] | | |
| ANSI/ASME B1.20.1 | ½ NPT | 400 bar [5,800 psi] | 572 bar [8,290 psi] | - | |
| | ¼ NPT | 1,000 bar [14,500 psi] | 1,480 bar [21,400 psi] | | |
| KS | PT ¼ | 1,000 bar [14,500 psi] | 1,480 bar [21,400 psi] | | |
| | PT ⅜ | 1,000 bar [14,500 psi] | 1,480 bar [21,400 psi] | | |
| ISO 7 | R ¼ | 1,000 bar [14,500 psi] | 1,480 bar [21,400 psi] | | |
| | R ⅜ | 1,000 bar [14,500 psi] | 1,480 bar [21,400 psi] | | |
| EN 837 | G ⅜ B | 400 bar [5,800 psi] | 572 bar [8,290 psi] | | <input type="checkbox"/> Copper <input type="checkbox"/> Stainless steel |
| | G ¼ B | 1,000 bar [15,000 psi] | 1,480 bar [21,400 psi] | | |
| | G ⅜ B | 1,000 bar [15,000 psi] | 1,480 bar [21,400 psi] | | |

Details must be tested separately in the respective application. The specified values for the overpressure limit serve only as a rough orientation. The values depend on the temperature, the sealing used, the selected torque, the type and the material of the mating thread and the prevailing operating conditions.

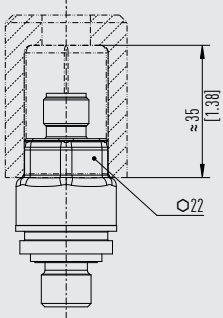
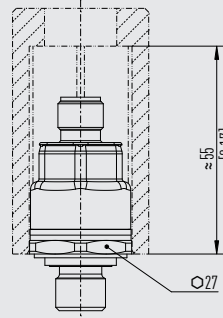
| Further details on: Process connection | |
|--|--|
| Max. measuring range | → See “Process connection” table above |
| Overpressure limit | → See “Process connection” table above |
| Sealing | → See “Process connection” table above |
| Pressure port diameter | As an option, for applications that can lead to pressure spikes, a restrictor with a pressure port of 0.3 mm is available. <ul style="list-style-type: none"> ■ 2.5 mm (standard for all process connections) ■ Restrictor 0.3 mm possible (for all process connections) |
| Socket wrench suitability | <div style="display: flex; justify-content: space-between;"> <div style="width: 45%;"> <p>Hexagon (SW 22) integrated into case</p>  </div> <div style="width: 45%;"> <p>Additional hexagon (SW 27) above the process connection</p>  </div> </div> |
| Possible restrictions | |
| Seal | <ul style="list-style-type: none"> ■ NBR ■ FPM/FKM ■ Copper ■ Stainless steel <p>→ Depending on the choice of sealing on the process connection, there may be restrictions in the permissible temperature range</p> |

- Other process connections and sealings on request.
- For further information on process connections, see technical information IN 00.14.

| Output signal | | |
|---|---|-----------------------|
| Signal type | | |
| CANopen® | Communication profile | CiA 301 |
| | Device profile | CiA 404 |
| | Layer-setting services and protocol | CiA 305 |
| | Automatic bit-rate detection | CiA 801 |
| | → See “Special documentation for CANopen®” | |
| Communication | | |
| Configuration of the CANopen® interface | It is possible to order the model MH-4-CAN already preconfigured. → See “Special documentation for CANopen®” | |
| Baud rate | 0 | 1000 kbit/s |
| | 1 | 800 kbit/s |
| | 2 | 500 kbit/s |
| | 3 | 250 kbit/s (standard) |
| | 4 | 125 kbit/s |
| | 5 | 100 kbit/s |
| | 6 | 50 kbit/s |
| | 7 | 20 kbit/s |

| Output signal | | |
|--------------------------------|---|--|
| Node ID | 001 ... 127 | 001 (standard) ¹⁾ |
| PDO mapping | A | Object 0x9130.01 (pressure value int32) and 0x6150.01 (status) |
| | B | Object 0x6130.01 (pressure value float) and 0x6150.01 (status) (standard) |
| | C | Object 0x7130.01 (pressure value int16) and 0x6150.01 (status) |
| PDO cycle | 00001 ... 65535 | Period in milliseconds (default: 100) |
| Decimal points | A | Optimum (standard) |
| | 0 ... 5 | Number of decimal points ¹⁾ |
| Transmission type | 001 ... 240 | Synchronous transmission 001 (standard) ¹⁾ |
| | 254 | Asynchronous cyclic transmission (event-timer-driven) |
| | 255 | Asynchronous transmission (event-timer-driven and/or PV change, PV limit exceeded) |
| Event timer | 0 | Automatic (standard) |
| | 00001 ... 65535 | Event timer in milliseconds ¹⁾ |
| Auto-operational | Z | Off via object 1F80 (standard) |
| | A | On via object 1F80 |
| Heartbeat | 0 | Without (standard) |
| | 00001 ... 65535 | Heartbeat in milliseconds ¹⁾ |
| Signal type | | |
| J1939 | SAE J1939 | |
| Communication | | |
| Baud rate | 2 | 500 kbit/s |
| | 3 | 250 kbit/s (standard) |
| TR-JPRIO | 0 | 0 |
| | 1 | 1 |
| | 2 | 2 |
| | 3 | 3 |
| | 4 | 4 |
| | 5 | 5 |
| | 6 | 6 (standard) |
| | 7 | 7 |
| Parameter Group Number (PGN) | → See "Special documentation J1939, 14547349" | |
| Suspect Parameter Number (SPN) | → See "Special documentation J1939, 14547349" | |
| Source address (SA) | 128 | 128 (standard) |
| | 000 ... 253 | Source address |
| Arbitrary Address Capable | 0 | 0 |
| | 1 | 1 (standard) |
| Industry Group | 0 | Global (standard) |
| | 1 | On-highway equipment |
| | 2 | Agricultural and forestry equipment |
| | 3 | Construction equipment |
| | 4 | Marine |
| | 5 | Stationary industrial process control |
| | 6 | Reserved |
| | 7 | Reserved |
| Vehicle System Instance | 0 ... 15 | 00 (standard) |

| Output signal | | |
|-------------------------------|--|-------------------|
| Vehicle System | 0 ... 127 | 000 (standard) |
| Function | 0 ... 255 | 000 (standard) |
| Function Instance | 0 ... 31 | 0 (standard) |
| ECU Instance | 0 | 0 (standard) |
| | 1 | 1 |
| | 2 | 2 |
| | 3 | 3 |
| | 4 | 4 |
| | 5 | 5 |
| | 6 | 6 |
| | 7 | 7 |
| TRR rate var. | 0 ... 65535 | TRR rate var. |
| | 100 | 100 ms (standard) |
| Voltage supply | | |
| Supply voltage | <ul style="list-style-type: none"> ■ CANopen: DC 9 ... 35 V ■ SAE J1939: DC 9 ... 35 V | |
| Current supply | <ul style="list-style-type: none"> ■ CANopen: < 50 mA ■ SAE J1939: < 50 mA | |
| Overtoltage resistance | DC 36 V | |
| Dynamic behaviour | | |
| Settling time per IEC 62828-1 | ≤ 3 ms | |
| Switch-on time | < 500 ms | |

1) Select a numerical value

| Electrical connection | |
|----------------------------------|-----------------------|
| Connection type | IP code ¹⁾ |
| MH-4-CAN | |
| Circular connector M12 x 1 5-pin | IP67 per IEC 60529 |
| MH-4-CAN (v) | |
| Circular connector M12 x 1 5-pin | IP67 per IEC 60529 |

1) The stated IP codes (per IEC 60529) only apply when plugged in using mating connectors that have the appropriate IP code.

| Further details on: Electrical connection | |
|--|--|
| Connection type | → See "Electrical connection" table above |
| Pin assignment | → See "Pin assignment" table below |
| Ingress protection (IP code) per IEC 60529 | → See "Electrical connection" table above |
| Short-circuit resistance | CAN-High/CAN-Low vs. U+/U- (U+: ≤ DC 24 V) |
| Reverse polarity protection | U+ vs. U- |
| Insulation voltage | DC 500 V |
| CAN bus impedance | A CAN bus impedance of 120 ohm is strictly required to reach a wide range and high number of involved persons with all transmission rates. In order to avoid gradients in potential, the shield must be connected along the entire bus with the lowest possible impedance. |

Pin assignment

Circular connector M12 x 1 (5-pin)

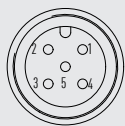

| | |
|---|----------|
| 1 | Shield |
| 2 | U+ |
| 3 | U- |
| 4 | CAN-High |
| 5 | CAN-Low |

Material

| | |
|---|---|
| Material (wetted) | Stainless steel 304L, PH grade steel |
| Material (in contact with the environment) | Stainless steel 304L, electrical connection made of highly resistant glass-fibre reinforced plastic (PBT) |

Operating conditions



| | |
|---|---|
| Medium temperature limit ¹⁾ | -40 ... +100 °C [-40 ... +212 °F] |
| Ambient temperature limit ¹⁾ | -40 ... +85 °C [-40 ... +185 °F] |
| Storage temperature limit | -40 ... +70 °C [-40 ... +158 °F] |
| Relative humidity per EN 60068-2-78 | 93 % at 55 °C [131 °F] |
| Pollution degree | 2 |
| Vibration resistance per IEC 60068-2-6 | 40g, 10 ... 2,000 Hz |
| Permanent vibration resistance per IEC 60068-2-6 | 10g, 10 ... 2,000 Hz |
| Shock resistance per IEC 60068-2-27 | 100g, 11 ms |
| Free fall in line with IEC 60068-2-31 | |
| Single instrument | 1 m [3.28 ft] |
| Multiple packaging | 0.5 m [1.64 ft] |
| Ingress protection (IP code) per IEC 60529 | → See table "Electrical connection" 6 |
| Service life | > 100 million load cycles |
| EMC | |
| ESD per ISO 10605 | ±8 kV contact discharge, ±15 kV air discharge |
| HF field per ISO 11452-2 | 100 V/m |
| BCI per ISO 11452-4 | 200 mA |
| Puls 1 per ISO 7637-2 | Level III |
| Puls 2a per ISO 7637-2 | Level III |
| Puls 2b per ISO 7637-2 | Level III |
| Puls 3a per ISO 7637-2 | Level III |
| Puls 3b per ISO 7637-2 | Level III |
| Fast Transient Pulses per ISO 7637-3 | Level IV |
| Radiation per CISPR 25 | 30 ... 1.000 MHz |

1) Depending on the choice of sealing on the process connection, the electrical connection and the UL approval, there may be restrictions in the medium and ambient temperature.
→ For restrictions, see "Process connection" and "Electrical connection".

Packaging and instrument labelling

| | |
|-----------------------------|---|
| Packaging | Multiple packaging (up to 25 pieces) |
| Instrument labelling | <ul style="list-style-type: none"> ■ WIKA product label, lasered ■ Customer-specific product label on request |

Approvals

| Logo | Description | Region |
|---|--|----------------|
|  | EU declaration of conformity | European Union |
| | EMC directive EN 61326 emission (group 1, class B) and immunity (industrial environments) | |
| | Pressure equipment directive | |
| | RoHS directive | |
|  | UKCA | United Kingdom |
| | Electromagnetic compatibility regulations | |
| | Pressure equipment (safety) regulations | |
| | Restriction of hazardous substances (RoHS) regulations | |

Optional approvals

| Logo | Description | Region |
|---|---------------------------------|----------------|
|  | UL Component approval | USA and Canada |

Manufacturer's information and certificates

| Logo | Description |
|------|----------------------|
| - | MTTF: > 100 years |
| - | China RoHS directive |

→ For approvals and certificates, see website

Dimensions in mm [in]

Circular connector M12 x 1, 5-pin

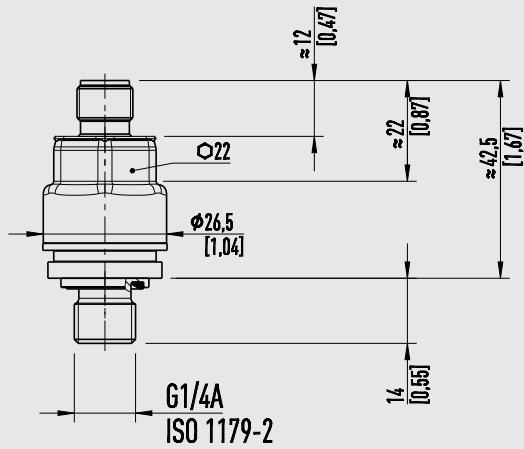

Weight: 80 g [0.18 lbs]

Accessories and spare parts

| Description | Order number |
|--|--------------|
| PCAN-USB adapter, cable set and power supply unit for configuration of CANopen®/J1939 design (for Windows® 98, ME, 2000, XP, Vista, Windows 7) | 7483167 |

Windows® is a registered trademark of Microsoft Corporation in the United States and other countries.

Ordering information

Model / Measuring range / Output signal / Electrical connection / Process connection / Sealing

© 12/2022 WIKA Alexander Wiegand SE & Co. KG, all rights reserved.
 The specifications given in this document represent the state of engineering at the time of publishing.
 We reserve the right to make modifications to the specifications and materials.
 In case of a different interpretation of the translated and the English data sheet, the English wording shall prevail.

