

Load pin

Heavy-duty version, with thin-film technology from 10 kN

Models F5308 standard, F53C8 ATEX, F53S8 safety version

WIKA data sheet FO 51.43



For further approvals
see page 4

Applications

- Crane systems, hoists, offshore, mobile working machines
- Industrial weighing technology
- Machine building and plant construction, manufacturing automation
- Chemical and petrochemical industries
- Weighing in safety applications

Special features

- Measuring ranges from 0 ... 10 kN [from 0 ... 2,248 lbf]
- Corrosion-resistant stainless steel version
- Integrated amplifier
- High long-term stability, high shock and vibration resistance
- Good reproducibility, easy installation



Load pins, models F5308 (lower fig.), F53S8 (upper fig.)

Description

Model F5308, F53C8 and F53S8 load pins are suitable for static and dynamic measuring tasks as a replacement for non-measuring bolts. They serve for determining tension and/or compression forces under harsh operating conditions.

Such load pins are very often used in hoists and crane systems, e.g. in construction cranes or in port and offshore cranes.

The corresponding technical and regional approvals of these force transducers are, of course, available as options.

The load pins are made of high-strength, corrosion-resistant 1.4542 stainless steel, the properties of which are ideal for the application areas.

As output signals, the common active current and voltage outputs are available (4 ... 20 mA, 0 ... 10 V). Redundant output signals and CANopen® protocols are also possible.

The load pins can be integrated into a certified WIKA overload protection with model ELMS1 (DIN EN ISO 13849-1 with PL d/cat. 3).

Specifications per VDI/VDE/DKD 2638

Model	F5308 and F53C8 with UL	F53S8
Rated force F_{nom} kN [lbf]	From 10 [ab 2,248]	
Relative linearity error $d_{lin}^{1)}$	$\pm 1 \% F_{nom} / \pm 1.5 \% F_{nom}$	
Relative repeatability error in unchanged mounting position b_{rg}	$\pm 0.2 \% F_{nom}$	
Temperature effect on		
the characteristic value TK_C	0.2 % $F_{nom} / 10$ K	
the zero signal TK_0	0.2 % $F_{nom} / 10$ K	
Force limit F_L	200 % F_{nom}	
Breaking force F_B	500 % F_{nom}	
Transverse force effect d_Q (signal at 100 % F_{nom} under 90°)	$\pm 5 \% F_{nom}$	
Rated displacement (typical) s_{nom}	< 0.1 mm [< 0.004 in]	
Material of the measuring body	<ul style="list-style-type: none"> ■ Corrosion-resistant stainless steel, 1.4542, ultrasound-tested 3.1 material ■ Version with 3.2 material available 	
Rated temperature $B_{T, nom}$	<ul style="list-style-type: none"> ■ -20 ... +80 °C [-4 ... +176 °F] ■ -40 ... +120 °C [-40 ... +248 °F] 	-20 ... +80 °C [-4 ... +176 °F]
Service temperature $B_{T, G}$	<ul style="list-style-type: none"> ■ -30 ... +80 °C [-22 ... +176 °F] ■ -40 ... +80 °C [-40 ... +176 °F] 	-30 ... +80 °C [-22 ... +176 °F]
Storage temperature $B_{T, S}$	-40 ... +85 °C [-40 ... +185 °F]	
Electrical connection	<ul style="list-style-type: none"> ■ Circular connector M12 x 1, 4- or 5-pin ■ CANopen® M12 x 1 circular connector, 5-pin ■ MIL connector 	<ul style="list-style-type: none"> ■ 2-connector version M12 x 1, 4-pin ■ MIL connector
Output signal (rated characteristic value) C_{nom}	<ul style="list-style-type: none"> ■ 4 ... 20 mA, 2-wire ■ 4 ... 20 mA, 3-wire ■ 2 x 4 ... 20 mA redundant ■ DC 0 ... 10 V, 3-wire ■ 2 x DC 0 ... 10 V redundant ■ Signal jump 4 ... 16 mA, 2-wire ⁴⁾ DC 2 ... 8 V, 3-wire ⁴⁾ ■ CANopen® <p>Protocol in accordance with CiA® 301, device profile CiA® 404, communication services LSS (CiA® 305), configuration of the instrument address and baud rate Sync/Async, Node/Lifeguarding, heartbeat; zero and span ± 10 % adjustable via entries in the object directory ²⁾</p>	<p>Redundant, opposing</p> <p>4 ... 20 mA / 20 ... 4 mA</p> <p>Version in accordance with requirements for functional safety per machinery directive 2006/42/EC as WIKA overload protection with model ELMS1 (DIN EN ISO 13849-1 with PL d/cat. 3).</p>
Current/power consumption	<ul style="list-style-type: none"> ■ Current output 4 ... 20 mA, 2-wire: signal current ■ Current output 4 ... 20 mA, 3-wire: < 8 mA ■ Voltage output: < 8 mA ■ CANopen®: < 1 W 	Voltage output: < 8 mA per channel
Supply voltage U_B	<ul style="list-style-type: none"> ■ DC 9 ... 36 V for current output ■ DC 13 ... 36 V for voltage output ■ DC 9 ... 36 V for CANopen® 	DC 10 ... 30 V
Load	<ul style="list-style-type: none"> ■ $\leq (U_B - 10 V) / 0.024$ A for current output ■ > 10 kΩ for voltage output 	<ul style="list-style-type: none"> ■ $\leq (U_B - 10 V) / 0.020$ A (channel 1) ■ $\leq (U_B - 7 V) / 0.020$ A (channel 2)
Reponse time	≤ 2 ms (within 10 ... 90 % F_{nom}) ³⁾	
Ingress protection (per IEC/EN 60529)		
Unplugged state	IP66, IP67	IP67
Plugged-in state	IP68, IP69, IP69K	
Electrical protection	Reverse polarity protection, overvoltage and short-circuit resistance	
Vibration resistance	20 g, 100 h, 50 ... 150 Hz (in accordance with DIN EN 60068-2-6)	
Shock resistance	In accordance with DIN EN 60068-2-27	
Immunity	In accordance with DIN EN 61326-1/DIN EN 61326-2-3 (optional EMC-strengthened versions)	
Intended use	Indoor and outdoor use, typically at altitudes of up to 2,500 m [8,202.5 ft] above sea level.	

1) Relative linearity error is specified in accordance with Directive VDI/VDE/DKD 2638 chapter 3.2.6.

2) Protocol in accordance with CiA® 301, device profile CiA® 404, communication service LSS (CiA® 305).

3) Further reponse times possible on request.

4) Further signal jumps are realisable on request.

CANopen® and CiA® are registered community trademarks of CAN® in Automation e. V.

Specifications per VDI/VDE/DKD 2638

Model	F53C8 ATEX/IECEX EX ib 1)	F53C8 ATEX/IECEX Ex d
Rated force F_{nom} kN [lbf]	From 10 [ab 2,248]	
Relative linearity error d_{lin} 2)	$\pm 1 \% F_{nom} / \pm 1.5 \% F_{nom}$	
Relative repeatability error in unchanged mounting position b_{rg}	$\pm 0.2 \% F_{nom}$	
Temperature effect on		
the characteristic value TK_c	0.2 % $F_{nom} / 10$ K	
the zero signal TK_0	0.2 % $F_{nom} / 10$ K	
Force limit F_L	200 % F_{nom}	
Breaking force F_B	500 % F_{nom}	
Transverse force effect d_Q (signal at 100 % F_{nom} under 90°) 3)	$\pm 5 \% F_{nom}$	
Rated displacement (typical) s_{nom}	< 0.1 mm [< 0.004 in]	
Material of the measuring body	<ul style="list-style-type: none"> ■ Corrosion-resistant stainless steel, 1.4542, ultrasound-tested 3.1 material ■ Version with 3.2 material available 	
Rated temperature $B_{T, nom}$	-20 ... +80 °C [-4 ... +176 °F]	
Service temperature $B_{T, G}$	Ex II 2G Ex ib IIC T4 Gb -25 °C < Tamb < +85 °C Ex II 2G Ex ib IIC T3 Gb -25 °C < Tamb < +100 °C Ex I M2 Ex ib I Mb -25 °C < Tamb < +85 °C Ex II 2G Ex ib IIC T4 Gb -40 °C < Tamb < +85 °C	Ex II 2G Ex d IIC T4 Gb -40 °C < Tamb < +85 °C
Storage temperature $B_{T, S}$	-40 ... +85 °C [-40 ... +185 °F]	
Electrical connection	<ul style="list-style-type: none"> ■ Circular connector M12 x 1, 4-pin ■ MIL connector ■ Cable gland 	Cable gland (only with ATEX/IECEX-Ex d - certified cable)
Output signal (rated characteristic value) C_{nom}	<ul style="list-style-type: none"> ■ 4 ... 20 mA, 2-wire 	<ul style="list-style-type: none"> ■ 4 ... 20 mA, 2-wire ■ 4 ... 20 mA, 3-wire
Current/power consumption	<ul style="list-style-type: none"> ■ Current output 4 ... 20 mA, 2-wire: signal current 	<ul style="list-style-type: none"> ■ Current output 4 ... 20 mA, 2-wire: signal current ■ Current output 4 ... 20 mA, 3-wire: < 8 mA
Supply voltage UB	DC 10 ... 30 V for current output	
Load	<ul style="list-style-type: none"> ■ $\leq (UB - 10 V) / 0.024 A$ for current output ■ > 10 kΩ for voltage output 	
Reponse time	≤ 2 ms (within 10 ... 90 % F_{nom}) 4)	
Ingress protection (per IEC/EN 60529)	IP67	
Electrical protection	Reverse polarity protection, overvoltage and short-circuit resistance	
Vibration resistance	20 g, 100 h, 50 ... 150 Hz (in accordance with DIN EN 60068-2-6)	
Shock resistance	In accordance with DIN EN 60068-2-27	
Immunity	In accordance with DIN EN 61326-1/DIN EN 61326-2-3 (optional EMC-strengthened versions)	

1) The load pin with ignition protection type "ib" should only be powered using galvanically isolated repeater power supplies.

Suitable repeater power supplies can be offered as an option e.g. 14255084.

2) Relative linearity error is specified in accordance with Directive VDI/VDE/DKD 2638 chapter 3.2.6.







3) This value can result if 100 % F_{nom} acts at 90° to the axis.

4) Further reponse times possible on request.

Approvals

Logo	Description	Region
	EU declaration of conformity EMC directive	European Union

Optional approvals

Logo	Description	Region
	ATEX directive ²⁾ per EN 60079-0:2012 and EN 60079-11:2012 (Ex ib) Hazardous areas Ex ib Ex II 2G Ex ib IIC T4 Gb $-25\text{ °C} < T_{\text{amb}} < +85\text{ °C}$ Ex II 2G Ex ib IIC T3 Gb $-25\text{ °C} < T_{\text{amb}} < +100\text{ °C}$ Ex I M2 Ex ib I Mb ²⁾ $-25\text{ °C} < T_{\text{amb}} < +85\text{ °C}$ Ex II 2G Ex ib IIC T4 Gb $-40\text{ °C} < T_{\text{amb}} < +85\text{ °C}$	European Union
	IECEX ²⁾ per IEC 60079-0:2011 (Ed. 6) and IEC 60079-11:2011 (Ed. 6) (Ex ib) Hazardous areas Ex ib Ex ib IIC T4/T3 Gb $-25\text{ °C} < T_{\text{amb}} < +85\text{ °C}$ Ex ib IIC T4 Gb $-25\text{ °C} < T_{\text{amb}} < +100\text{ °C}$ Ex ib I Mb ²⁾ $-25\text{ °C} < T_{\text{amb}} < +85\text{ °C}$ Ex ib IIC T4 Gb $-40\text{ °C} < T_{\text{amb}} < +85\text{ °C}$	International
	UL ¹⁾ per UL 61010-1 and CSA C22.2 NO. 61010-1 Component approval	USA and Canada
	EAC EMC directive	Eurasian Economic Community
	EAC Ex ²⁾ Hazardous areas Ex ib Ex ib IIC T3 Gb $-40\text{ °C} < T_{\text{amb}} < +100\text{ °C}$ Ex ib IIC T3 Gb $-45\text{ °C} < T_{\text{amb}} < +100\text{ °C}$ Ex ib IIC T4 Gb $-40\text{ °C} < T_{\text{amb}} < +85\text{ °C}$ Ex ib IIC T4 Gb $-45\text{ °C} < T_{\text{amb}} < +100\text{ °C}$	Eurasian Economic Community
	DNV (option) ¹⁾ Ships, shipbuilding (e.g. offshore) ■ DNV standard: DNV-ST-0377 ■ DNV standard: DNV-ST-0378	International

1) Only with model F53C8.

2) Only possible with cable gland.

→ For approvals and certificates, see website.

Mounting situation of the load pin

Pin retainer (in accordance with DIN 15058)

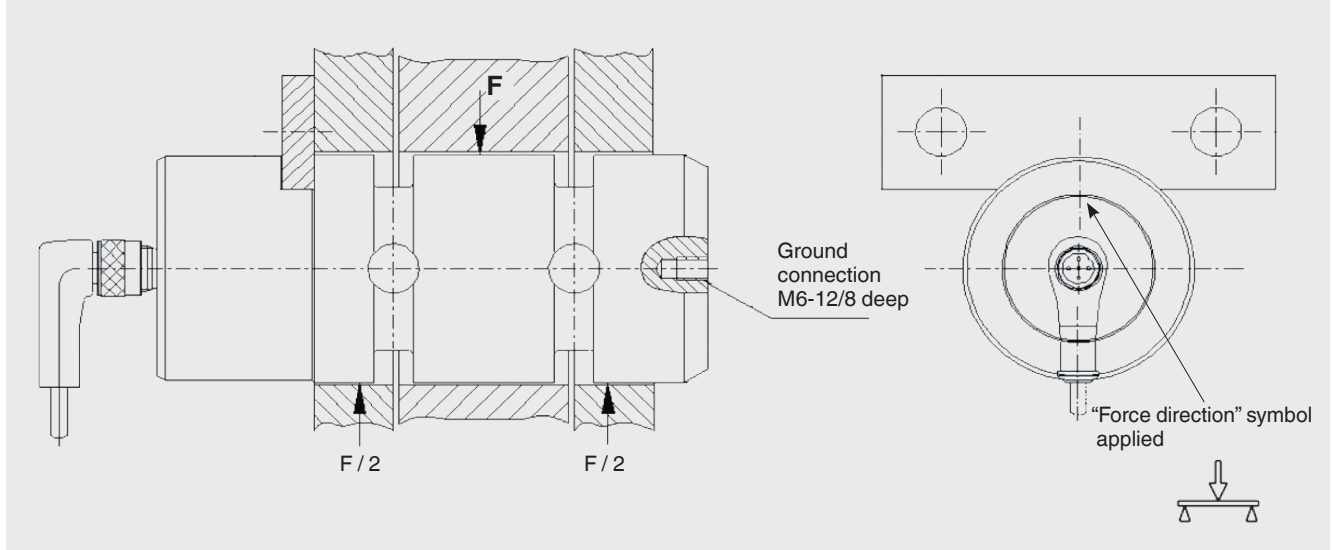

Dimensioning: The customer-specific load pin drawing of the respective order number has priority.

Pin assignment, analogue output

Abbreviations, definitions

Signal	Description
UB	Voltage source for the sensor
UB+	Sensor voltage supply (+)
UB-	Sensor voltage supply (-)
S+	Output signal (+)
S-	Output signal (-)
0V	0V potential

Signal	Description
(A)	Ammeter
(V)	Voltmeter
(+)	Voltage source
—	Switch
(⊕)	Shield [ground]

For models F5308 and F53C8 with UL

Output 4 ... 20 mA, 2-wire

Circular connector M12 x 1, 5-pin

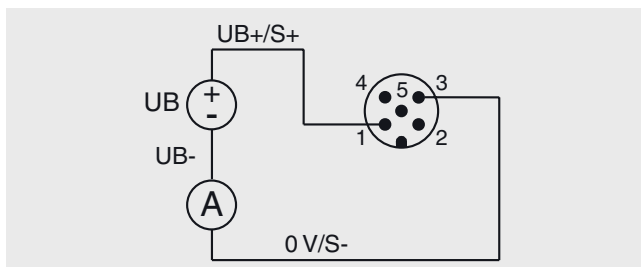

Signal	4 ... 20 mA, 2-wire	Cable colour
UB+/S+	1	Brown
0V/S-	3	Black
Shield (⊕)	Case / Connector	-

Cable colours are only valid when using the standard WIKA cable, e.g. order number: 14259454

Pin assignment, analogue output

Abbreviations, definitions

Signal	Description
UB	Voltage source for the sensor
UB+	Sensor voltage supply (+)
UB-	Sensor voltage supply (-)
S+	Output signal (+)
S-	Output signal (-)
0V	0V potential

Signal	Description
(A)	Ammeter
(V)	Voltmeter
(+)	Voltage source
—	Switch
(⊕)	Shield [ground]

Output 4 ... 20 mA, 3-wire

Circular connector M12 x 1, 5-pin

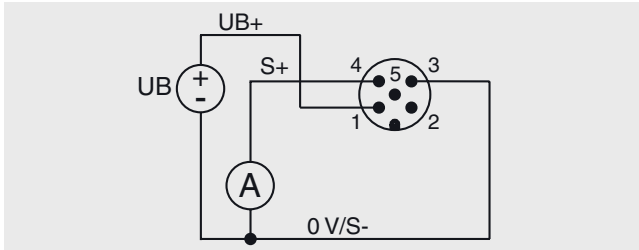

Signal	4 ... 20 mA, 3-wire	Cable colour
UB+	1	Brown
S+	4	Black
0V/S-	3	Blue
Shield (⊕)	Case / Connector	-

Cable colours are only valid when using the standard WIKA cable, e.g. order number: 14259454

Output 0 ... 10 V, 3-wire

Circular connector M12 x 1, 5-pin

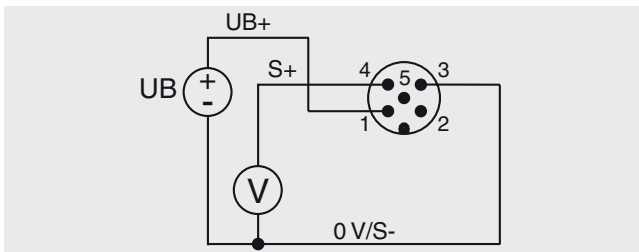

Signal	0 ... 10 V, 3-wire	Cable colour
UB+	1	Brown
S+	4	Black
0V/S-	3	Blue
Shield (⊕)	Case / Connector	-

Cable colours are only valid when using the standard WIKA cable, e.g. order number: 14259454

For model F53C8

Output 4 ... 20 mA, 2-wire for ATEX Ex ib and Ex d

Circular connector M12 x 1, 4-pin

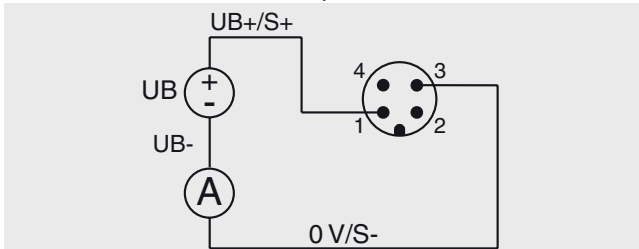

Signal	ATEX/IECEX EX ib and Ex d 4 ... 20 mA, 2-wire	Cable colour
UB+/S+	1	Brown
0V/S-	3	Blue
Shield (⊕)	Case / Connector	-

Cable colours are only valid when using the standard WIKA cable, e.g. order number: 14259454

Output 4 ... 20 mA, 3-wire for ATEX Ex d

Circular connector M12 x 1, 4-pin

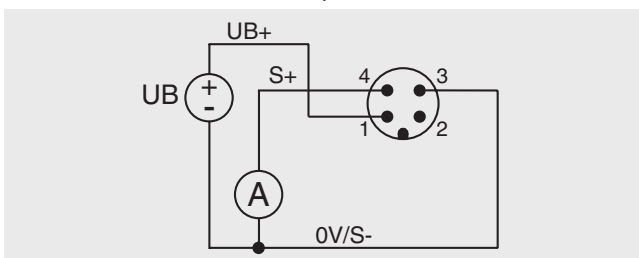

Signal	ATEX/IECEX Ex d 4 ... 20 mA, 3-wire	Cable colour
UB+	1	Brown
0V/S-	3	Blue
S+	4	Black
Shield (⊕)	Case / Connector	-

Cable colours are only valid when using the standard WIKA cable, e.g. order number: 14259454

Abbreviations, definitions

Signal	Description
UB	Voltage source for the sensor
UB+	Sensor voltage supply (+)
UB-	Sensor voltage supply (-)
UR	Voltage source for the signal jump
UR+	Signal jump supply voltage (+)
UR-	Signal jump supply voltage (-)
S+	Output signal (+)
S-	Output signal (-)
0V	0V potential

Signal	Description
\textcircled{A}	Ammeter
\textcircled{V}	Voltmeter
$\textcircled{+}$	Voltage source
\sim	Switch
$\textcircled{\oplus}$	Shield [ground]

For model F5308 with signal jump

Output 4 ... 20 mA, 2-wire with signal jump

Circular connector M12 x 1, 4-pin

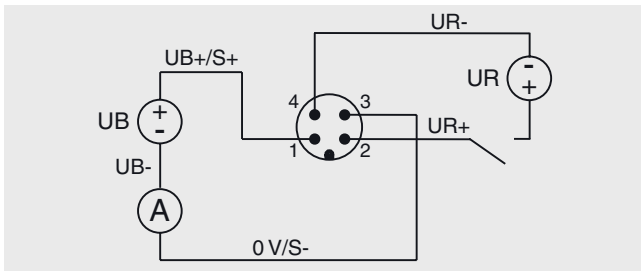

Signal	4 ... 20 mA, 2-wire	Cable colour
UB+/S+	1	Brown
0V/S-	3	Blue
UR+	2	White
UR-	4	Black
Shield $\textcircled{\oplus}$	Case / Connector	-

Cable colours are only valid when using the standard WIKA cable, e.g. order number: 14259454

Output 4 ... 20 mA, 3-wire with signal jump

Circular connector M12 x 1, 4-pin

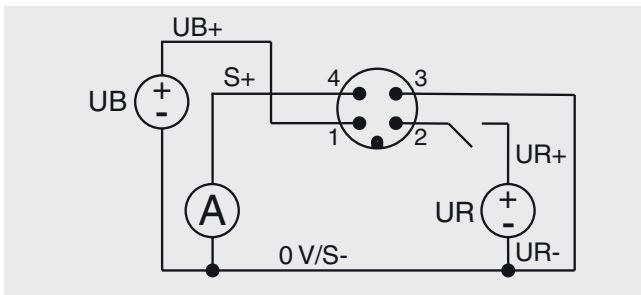

Signal	4 ... 20 mA, 3-wire	Cable colour
UB+	1	Brown
0V/S-	3	Blue
UR+	2	White
UR-	3	Blue
S+	4	Black
Shield $\textcircled{\oplus}$	Case / Connector	-

Cable colours are only valid when using the standard WIKA cable, e.g. order number: 14259454

Output 0 ... 10 V, 3-wire with signal jump

Circular connector M12 x 1, 4-pin

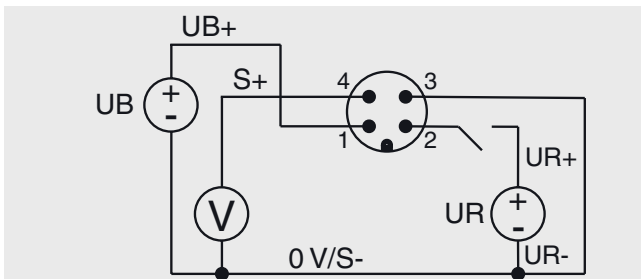

Signal	0 ... 10 V, 3-wire	Cable colour
UB+	1	Brown
0V/S-	3	Blue
UR+	2	White
UR-	3	Blue
S+	4	Black
Shield $\textcircled{\oplus}$	Case / Connector	-

Cable colours are only valid when using the standard WIKA cable, e.g. order number: 14259454

Redundant pin assignment with 1 x connector

Abbreviations, definitions

Signal	Description
UB	Voltage source for the sensor
UB+	Sensor voltage supply (+)
UB-	Sensor voltage supply (-)
S+	Output signal (+)
S-	Output signal (-)
CH1	Channel 1
CH2	Channel 2
CH1+2	Channel 1 and channel 2
0V	0V potential

Signal	Description
(A)	Ammeter
(V)	Voltmeter
(+)	Voltage source
⌋	Switch
(⊕)	Shield [ground]

For models F5308 and F53C8 with UL

Output 4 ... 20 mA, 2-wire redundant with 1 x connector

Circular connector M12 x 1, 5-pin

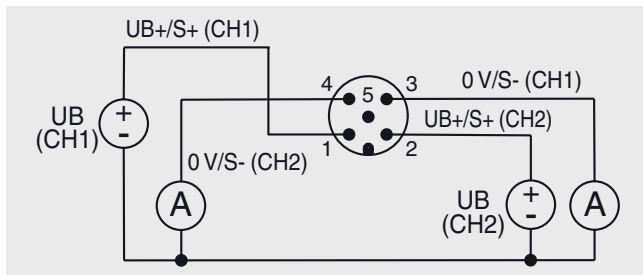

Signal	4 ... 20 mA, 2-wire	Cable colour
UB+/S+ (CH1)	1	Brown
UB+/S+ (CH2)	2	White
0V/S- (CH1)	3	Blue
0V/S- (CH2)	4	Black
Shield (⊕)	Case / Connector	-

Cable colours are only valid when using the standard WIKA cable, e.g. order number: 14259454

Output 4 ... 20 mA, 3-wire redundant with 1 x connector

Circular connector M12 x 1, 5-pin

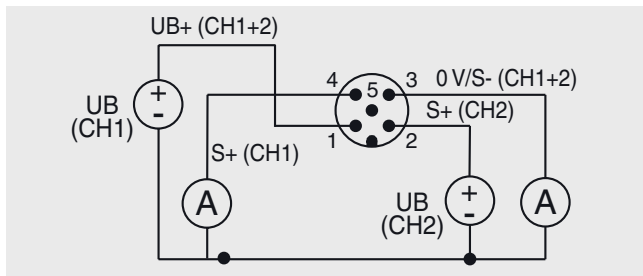

Signal	4 ... 20 mA, 3-wire	Cable colour
UB+ (CH1+2)	1	Brown
0V/S- (CH1+2)	3	Blue
S+ (CH1)	4	Black
S+ (CH2)	2	White
Shield (⊕)	Case / Connector	-

Cable colours are only valid when using the standard WIKA cable, e.g. order number: 14259454

Output 0 ... 10 V, 3-wire redundant with 1 x connector

Circular connector M12 x 1, 5-pin

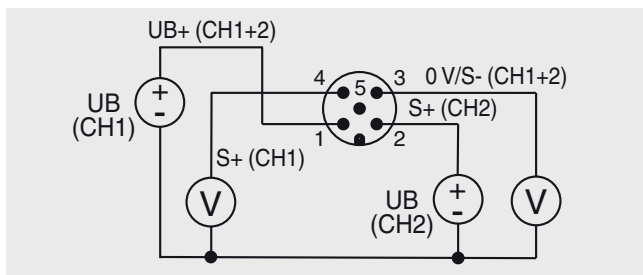

Signal	0 ... 10 V, 3-wire	Cable colour
UB+ (CH1+2)	1	Brown
0V/S- (CH1+2)	3	Blue
S+ (CH1)	4	Black
S+ (CH2)	2	White
Shield (⊕)	Case / Connector	-

Cable colours are only valid when using the standard WIKA cable, e.g. order number: 14259454

Redundant pin assignment, opposing, with 2 x connector

Abbreviations, definitions

Signal	Description
UB	Voltage source for the sensor
UB+	Sensor voltage supply (+)
UB-	Sensor voltage supply (-)
S+	Output signal (+)
S-	Output signal (-)
CH1	Channel 1
CH2	Channel 2
CH1+2	Channel 1 and channel 2
0V	0V potential

Signal	Description
(A)	Ammeter
(V)	Voltmeter
(+/-)	Voltage source
⌵	Switch
(⊕)	Shield [ground]

For model F53S8

Output 4 ... 20 mA, 3-wire redundant with, opposing, 2 x connector

Circular connector M12 x 1, 4-pin

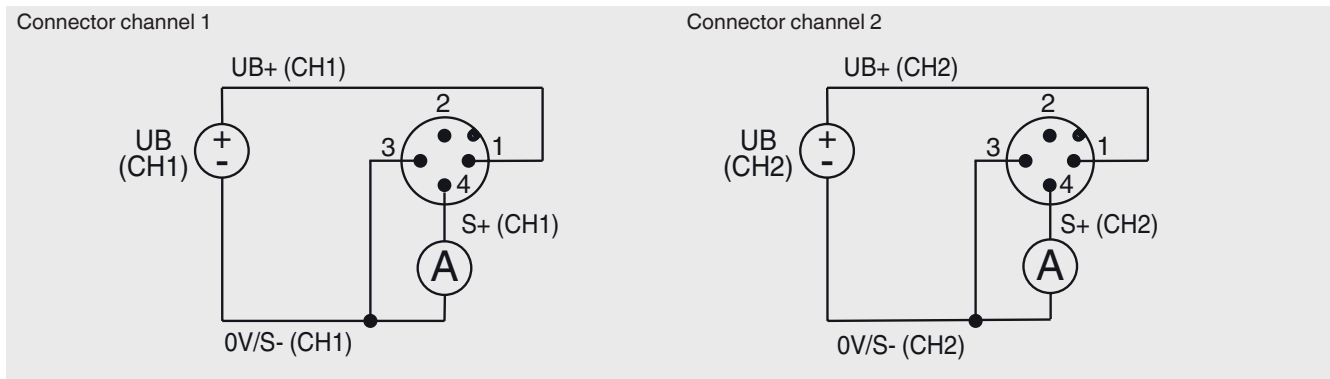

Circular connector M12 x 1, 4-pin

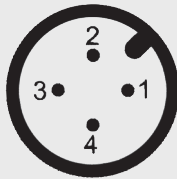

4 ... 20 mA, 3-wire redundant opposing			
Signal	Connector channel 1	Connector channel 2	Cable colour
UB+	1	1	Brown
0V/S-	3	3	Blue
S+	4	4	Black
Shield (⊕)	Case / Connector	Case / Connector	-

Cable colours are only valid when using the standard WIKA cable, e.g. order number: 14259454

2-connector variant, e.g. in combination with ELMS1 overload protection (F53S8).

Version in accordance with requirements for functional safety in accordance with the Machinery Directive 2006/42/EC.

Pin assignment for MIL connector

Abbreviations, definitions

Signal	Description
UB	Voltage source for the sensor
UB+	Sensor voltage supply (+)
UB-	Sensor voltage supply (-)
S+	Output signal (+)
S-	Output signal (-)
CH1	Channel 1
CH2	Channel 2
CH1+2	Channel 1 and channel 2
0V	0V potential

Signal	Description
Ⓐ	Ammeter
Ⓥ	Voltmeter
⊕	Voltage source
⌵	Switch
⊕	Shield [ground]

For the models F5308, F53C8 with UL, F53S8 and F53C8 Atex Ex ib

MIL connector - 1-channel

MIL-CA3102E 16S-1P-B

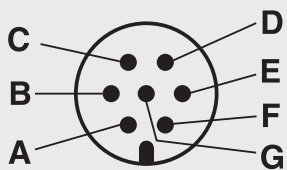

1-channel 4 ... 20 mA, 2-wire

Signal	Pin	Cable colour
UB+/S+	A	Brown
0V/S-	C	Blue
Shield ⊕	Cable gland	-

1-channel 4 ... 20 mA, 3-wire

Signal	Pin	Cable colour
UB+	A	Brown
0V/S-	C	Blue
S+	D	Black
Shield ⊕	Cable gland	-

1-channel 0 ... 10 V, 3-wire

Signal	Pin	Cable colour
UB+	A	Brown
0V/S-	C	Blue
S+	D	Black
Shield ⊕	Cable gland	-

Cable colours are only valid when using the standard WIKA cable, e.g. order number: 79100531

MIL connector - redundant

MIL-CA3102E 16S-1P-B

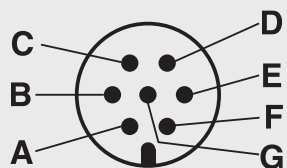

Redundant 4 ... 20 mA, 2-wire

Signal	Pin	Cable colour
UB+/S+ (CH1)	A	Brown
0V/S- (CH1)	C	Blue
UB+/S+ (CH2)	D	White
0V/S- (CH2)	F	Black
Shield ⊕	Cable gland	-

Redundant 4 ... 20 mA, 3-wire

Signal	Pin	Cable colour
UB+ (CH1)	A	Brown
UB+ (CH2)	B	White
0V/S- (CH1)	C	Green
S+ (CH1)	D	Yellow
0V/S- (CH2)	E	Grey
S+ (CH2)	F	Pink
Shield ⊕	Cable gland	-

Redundant 0 ... 10 V, 3-wire

Signal	Pin	Cable colour
UB+ (CH1)	A	Brown
UB+ (CH2)	B	White
0V/S- (CH1)	C	Green
S+ (CH1)	D	Yellow
0V/S- (CH2)	E	Grey
S+ (CH2)	F	Pink
Shield ⊕	Cable gland	-

Cable colours are only valid when using the standard WIKA cable, e.g. order number: 79100531

Pin assignment for CANopen® in accordance with CiA®303-1

Abbreviations, definitions

Signal	Description
CAN-SHLD, shield 	CAN shield
CAN-V+	CAN external positive voltage supply for the supply of the sensor
CAN-GND	CAN external 0 V potential for the supply of the sensor
CAN-High	CAN_H bus line (dominant high)
CAN-Low	CAN_L bus line (dominant low)

For models F5308 and F53C8 with UL

CANopen® output

Circular connector M12 x 1, 5-pin

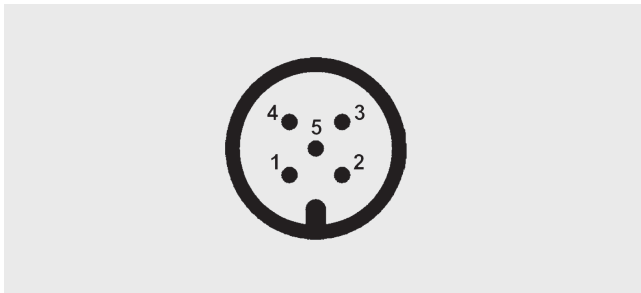

Signal	Pin	Cable colour
CAN-SHLD, shield 	1 / case / connector	Brown
CAN-V+	2	Blue
CAN-GND	3	White
CAN-High	4	Blue
CAN-Low	5	Black

Cable colours are only valid when using the standard WIKA cable, e.g. order number: 14259454

CANopen® output with Y-connector

Socket M12 x 1, 5-pin / connector M12 x 1, 5-pin

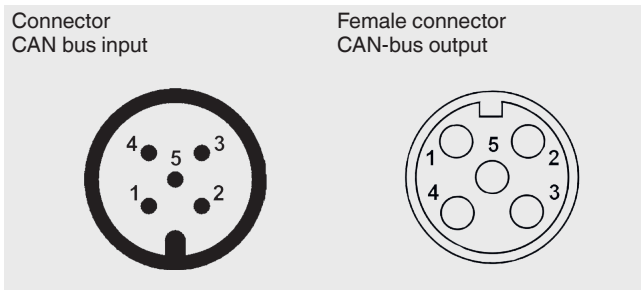

The socket and connector are connected internally.

Socket, M12 x 1, 5-pin / connector, M12 x 1, 5-pin		
Signal	Pin	Cable colour
CAN-SHLD, shield 	1 / case / connector	Brown
CAN-V+	2	Blue
CAN-GND	3	White
CAN-High	4	Blue
CAN-Low	5	Black

Cable colours are only valid when using the standard WIKA cable, e.g. order number: 14259454

Connect the cable shield to the case of the force transducer.

In the cables of the accessories, the cable shield is connected by means of the knurled nut, thus connecting it to the case of the force transducer. When using extensions, only shielded and low-capacitance cables should be used.

The permitted maximum and minimum lengths of cable are defined in ISO 11898-2. Care should also be taken with the shielding to ensure a high-quality connection.

Short description of the signal jump electronics

Amplifier 4 ... 20 mA or 0 ... 10 V for signal jump applications with 2-channel computer control.

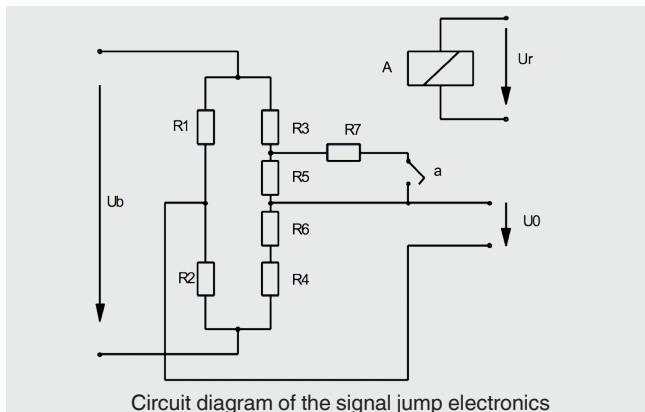

With these force transducers, four variable resistors (R1 ... R4) are connected together to form a Wheatstone bridge. When the measuring body deforms, the opposing resistors are stretched or compressed in the same way. This leads to a detuning of the bridge and a diagonal voltage U_0 .

The test resistor R7 is now important in connection with checking the subsequent amplifier circuit and the subsequent signal paths. This is switched parallel to the resistor R5 via the relay contact (a) as soon as the excitation voltage U_r of the relay A is present. The connection of the resistor R7 causes a defined, always constant, detuning of the zero point (diagonal voltage) of the Wheatstone bridge.

An external controller that is independent of the force transducer must monitor the safe functioning of the force transducer. The functional test with a signal jump of 4 mA / 2 V is executed at an interval of 24 hours. The controller activates the relay A, thus changing the output signal of the force transducer in a defined manner.

If the expected change in the output signal occurs, it can be assumed that the entire signal path from the Wheatstone bridge per the amplifier through to the output is functioning correctly. If no signal change occurs, then it can be concluded that there is an error in the signal path.



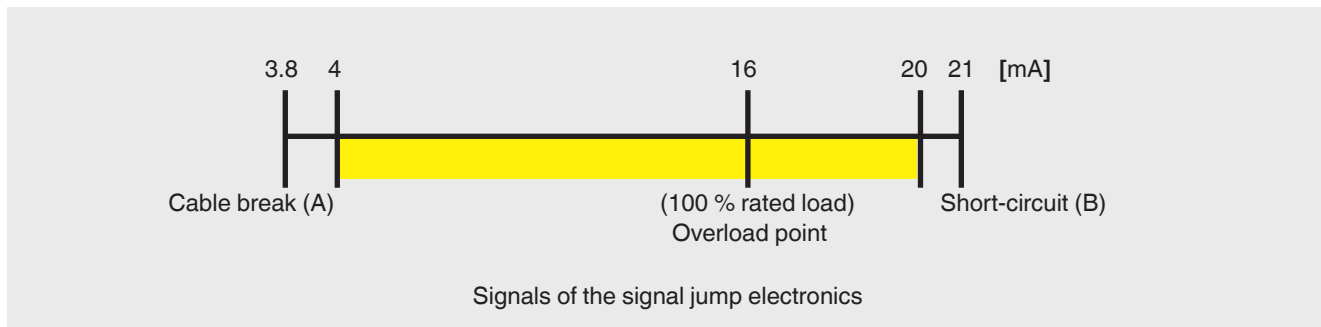

Furthermore, the measuring signal should be checked by the controller for min. (A) and max. (B) signal values in order to detect any cable breaks or short circuits that may occur.

The default setting of the force transducers with a current output of 4 ... 20 mA for overload detection is, for example:



With a fixed signal jump of, for example, 4 mA, the test cycle can then be triggered, in any operating state, by activating the test relay. The upper measuring range limit of 20 mA will never be reached and thus the checking of the signal jump is enabled.

Accessories

Model EZE53 connector with moulded cable					
Model	Description	Temperature range	Cable diameter	Cable colour	Order number
	Straight version, cut to length, 4-pin, PUR cable, UL listed, IP67	-20 ... +80 °C [-4 ... +176 °F]	Ø 4.75 mm - Ø 5.7 mm [Ø 0.18 in - Ø 0.22 in]	2 m [6.6 ft]	14259451
				5 m [16.4 ft]	14259453
				10 m [32.8 ft]	14259454
	Straight version, cut to length, 5-pin, PUR cable, UL listed, IP67	-20 ... +80 °C [-4 ... +176 °F]	Ø 4.75 mm - Ø 5.7 mm [Ø 0.18 in - Ø 0.22 in]	2 m [6.6 ft]	14259458
				5 m [16.4 ft]	79100672
				10 m [32.8 ft]	14259472
	Angled version, cut to length, 4-pin, PUR cable, UL listed, IP67	-20 ... +80 °C [-4 ... +176 °F]	Ø 5.05 mm - Ø 6 mm [Ø 0.2 in - Ø 0.24 in]	2 m [6.6 ft]	14259452
				5 m [16.4 ft]	14293481
				10 m [32.8 ft]	14259455
	Angled version, cut to length, 5-pin, PUR cable, UL listed, IP67	-20 ... +80 °C [-4 ... +176 °F]	Ø 5.05 mm - Ø 6 mm [Ø 0.2 in - Ø 0.24 in]	2 m [6.6 ft]	79101493
				5 m [16.4 ft]	79100686
				10 m [32.8 ft]	On request

Other cable lengths and cable types (e.g. for MIL connector) are available on request.

Ordering information

Model / Rated force / Relative linearity error / Temperature range / Output signal / Electrical connection / Optional approvals, certificates / Pin assignment / Accessories

© 06/2019 WIKA Alexander Wiegand SE & Co. KG, all rights reserved.
The specifications given in this document represent the state of engineering at the time of publishing.
We reserve the right to make modifications to the specifications and materials.
In the case of a different interpretation of the translated and the English data sheet, the English wording shall prevail.

